

WASTED SPARK USING TWO POST COILS

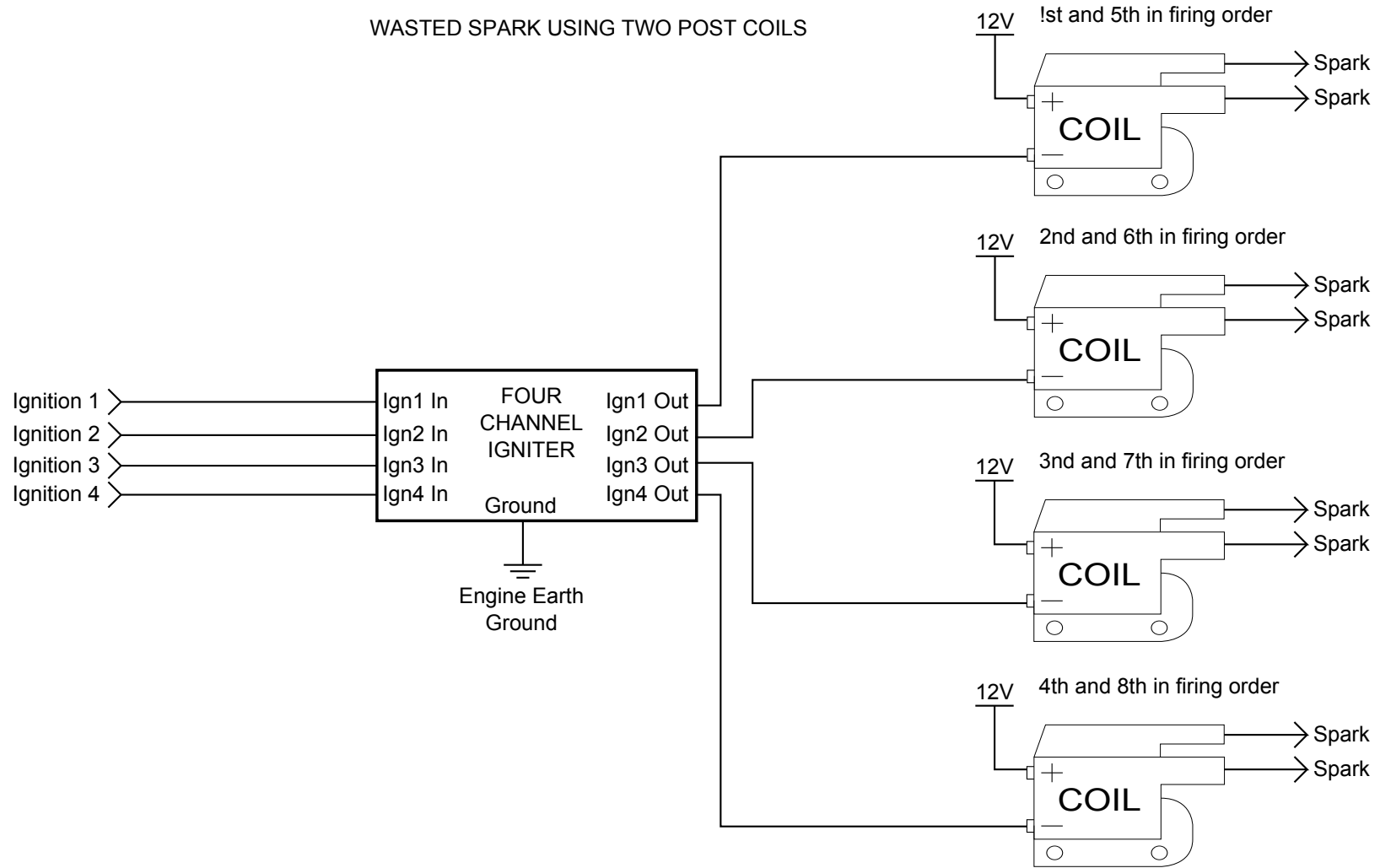

While every effort is taken to ensure correctness, no responsibility will be taken for the consequences of any inaccuracies or omissions in this drawing.



AUTHOR
**8 Cylinder Dual Post
 Wasted Spark Example**

DATE
 12/8/2009
 VERSION
 1.0

DRAWING ID
 I25
 AUTHOR
 PW